

## GENERAL INFORMATION

Rack mount dimmer pack that can be operated stand-alone or combined into small systems

### APPLICATIONS

- Small road show or band tour
- Small and Medium theatres
- Event and exhibition

### PERFORMANCE

- Versatile control via DMX-512A and/or SmartLink®
- 16-Bit DSP for fast accurate control
- Built-in presets and sequencer for stand-alone operation
- Stand-by Switch
- Auto-Restart Function
- True discrete SCR's for reliability
- Intuitive and quick dimmer test functions
- User-selectable curves

### MECHANICAL FEATURES

- 19-inch 2U pack
- 3, 6 or 12 dimmer packs available
- Rugged steel industrial enclosure
- Ultra-quiet cross flow cooling fan
- All magnetic, fully rated circuit breakers
- Flexible load connector option
- CE compliant

## ORDERING INFORMATION

### SmartPack CE Rack Mount Packs

| PART #       | DESCRIPTION                                  |
|--------------|--|
| 7020A1106-TM | 3 x 5kW SmartPack ND, terminals*             |
| 7020A1106-CF | 3 x 5kW SmartPack ND, CEE 32A*               |
| 7020A1106-H  | 3 x 5kW SmartPack ND, Harting HAN 6HSB       |
| 7020A1102-TM | 6 x 3.2kW SmartPack SP, terminals            |
| 7020A1102-K  | 6 x 3.2kW SmartPack SP, Schuko               |
| 7020A1102-CF | 6 x 3.2kW SmartPack SP, CEE 16A              |
| 7020A1104-TM | 6 x 3.2kW SmartPack ND, terminals            |
| 7020A1104-K  | 6 x 3.2kW SmartPack ND, Schuko               |
| 7020A1104-F  | 6 x 3.2kW SmartPack ND, NF French            |
| 7020A1104-CF | 6 x 3.2kW SmartPack ND, CE 16A               |
| 7020A1104-H  | 6 x 3.2kW SmartPack ND, Harting (Dual)       |
| 7020A1104-V  | 6 x 3.2kW SmartPack ND, Socapex (Dual)       |
| 7020A1103-TM | 12 x 2.3kW SmartPack SP, terminals           |
| 7020A1103-P  | 12 x 2.3kW SmartPack SP, PowerCon (Dual)     |
| 7020A1103-W  | 12 x 2.3kW SmartPack SP, Wieland ST17 (Dual) |
| 7020A1103-H  | 12 x 2.3kW SmartPack SP, Harting             |
| 7020A1103-V  | 12 x 2.3kW SmartPack SP, Socapex             |
| 7020A1105-TM | 12 x 2.3kW SmartPack ND, terminals           |
| 7020A1105-P  | 12 x 2.3kW SmartPack ND, PowerCon (Dual)     |
| 7020A1105-W  | 12 x 2.3kW SmartPack ND, Wieland St17 (Dual) |
| 7020P1105-H  | 12 x 2.3kW SmartPack ND, Harting             |
| 7020A1105-V  | 12 x 2.3kW SmartPack ND, Socapex             |
| 7020A2013    | SmartPack Rear Mount Kit (Set of 2)          |

\* This pack do not support SmartLink

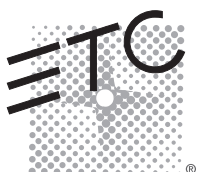

## SPECIFICATIONS

## GENERAL

- Approvals and Certifications:
  - CE compliant
  - ESTA DMX512A compliant

## ELECTRICAL

- Maximum feed capacity:
  - 3 x 32A, Three Phase, 4-wire & ground
- 230VAC, 47 – 63 Hz
- Strain relief for up to 6/5 SO cable provided for power input to terminal lug
- Input lugs accept up to AWG 2 cable
- DMX input and thru connectors
- RJ45 connectors for SmartLink® rack-to-rack communication (Except 3x5kW packs)
- Fully rated magnetic circuit breakers to eliminate nuisance tripping
- High quality 100µs toroidal filters
- Modular SCR and bonded heat sink assembly with superior surge, thermal transfer, and short-circuit immunity
- 2500V isolation between control and power components
- Switch puts unit in Stand-by mode

## MECHANICAL

- Rack mount unit requires only 2 EIA 19" rack spaces
- 18-gauge steel construction
- Fine-textured, scratch resistant paint
- Mounting hardware with integral carrying handles
- Recessed control connectors and protected circuit breakers

## THERMAL

- Ambient operation temperature between 0°C and 35°C
- Humidity between 30 – 95% (non-condensing)
- Low noise temperature controlled fan
- Front-to-back cooling for better airflow in a stacked application

## USER INTERFACE

- High-contrast 20-character by 2-line backlit LCD
- 6-button blue phosphorescent keypad
- Power status indicator LED (Blue)
- DMX status indicator LED (Green)

## FEATURES

- DMX addressing via user interface
- Soft patch any dimmer to any DMX channel
- 32 programmable presets
- Sequencer with programmable fade and hold times allows stand-alone operation
- SmartLink provides synchronisation of presets and sequence across multiple packs (except 3x5kW packs)

## SPECIFICATIONS

## FEATURES

- Auto-Restart function returns unit to previous state when power is cycled
- Power switch puts unit in stand-by mode
- Non-volatile Flash preset storage
- Five selectable dimmer output curves:
  - IES modified square law
  - Linear
  - Switched (50% threshold)
  - Fluorescent with adjustable cut-off
  - Adjustable Pre-Heat
- Multi-language capability – English, Spanish, German and French

## FRONT PANEL DETAIL

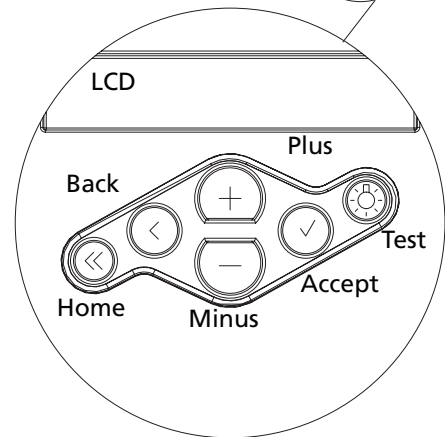
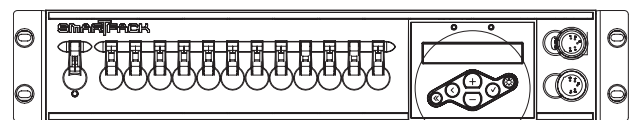

## SMARTLINK CONNECTION

## REAR PANEL DETAIL

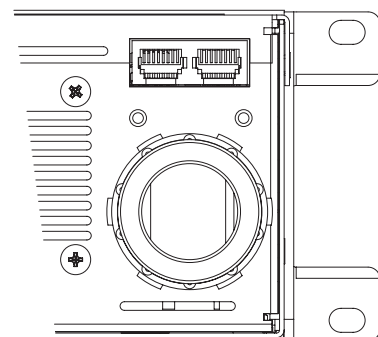

REAR PANEL OPTIONS

12 x PowerCon® (P)

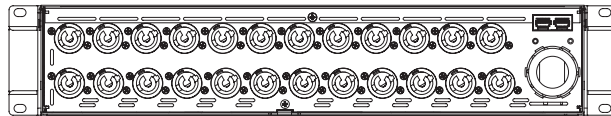

Single 6-circuit Multi-pin with selectable offset (V)

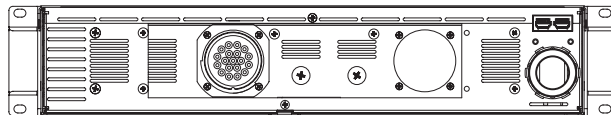

Dual 6-circuit Multi-pin with selectable offset (V)

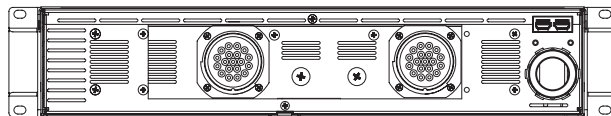

6 x Terminal (TM)

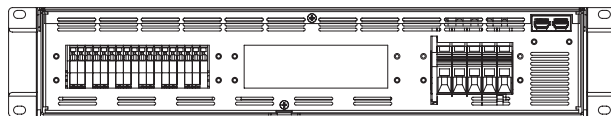

12 x Terminal (TM)

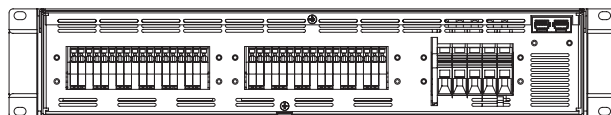

PHYSICAL

**SmartPack Dimensions**

| MODEL            | HEIGHT | WIDTH | DEPTH |
|------------------|--------|-------|-------|
|                  | mm     | mm    | mm    |
| 3 channel packs  | 88     | 483   | 470   |
| 6 channel packs  | 88     | 483   | 470   |
| 12 channel packs | 88     | 483   | 470   |

**SmartPack Weights\***

| MODEL            | WEIGHT      | SHIPPING WEIGHT |
|------------------|-------------|-----------------|
|                  | kgs         | kgs             |
| 3 channel packs  | 12.7 - 15.4 | 15.4 - 18.1     |
| 6 channel packs  | 12.7 - 15.4 | 15.4 - 18.1     |
| 12 channel packs | 13.6 - 16.3 | 16.3 - 19.1     |

\*Weights vary depending on connector type

Top View

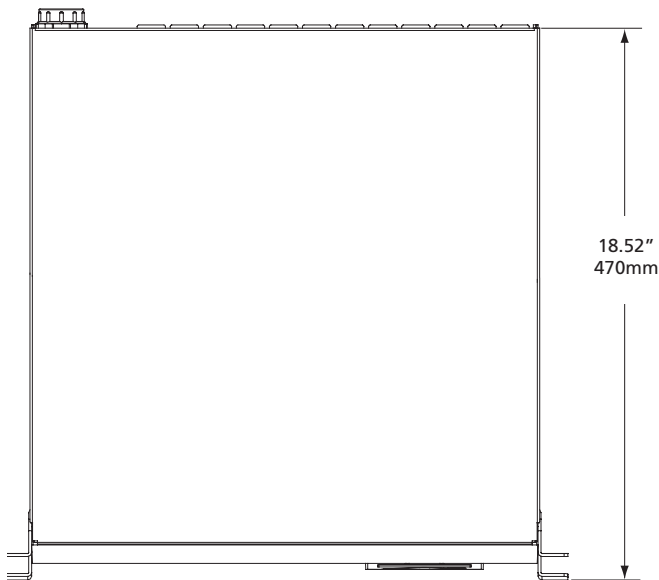

Front View

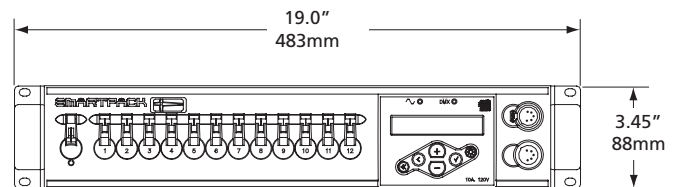

Side View

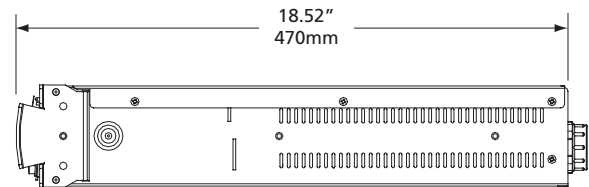

**AVAILABLE FROM**



Back View (Shown with Stage Pin)

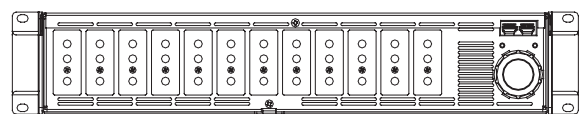

**Corporate Headquarters** • 3031 Pleasant View Rd, PO Box 620979, Middleton WI 53562 0979 USA • Tel +1 608 831 4116 • Fax +1 608 836 1736  
**London, UK** • Unit 26-28, Victoria Industrial Estate, Victoria Road, London W3 6UU, UK • Tel +44 (0)20 8896 1000 • Fax +44 (0)20 8896 2000  
**Rome, IT** • Via Pieve Torina, 48, 00156 Rome, Italy • Tel +39 (0)63 211 1683 • Fax +44 (0) 20 8752 8486  
**Holzkirchen, DE** • Ohmstrasse 3, 83607 Holzkirchen, Germany • Tel +49 (80 24) 47 00-0 • Fax +49 (80 24) 47 00-3 00  
**Hong Kong** • Room 1801, 18/F, Tower 1 Phase 1, Enterprise Square, 9 Sheung Yuet Road, Kowloon Bay, Kowloon, Hong Kong • Tel +852 2799 1220 • Fax +852 2799 9325  
**Web** • www.etconnect.com • Copyright©2011 ETC. All Rights Reserved. All product information and specifications subject to change. 7020L1003-GB Rev. B DRAFT 03/11